

(1:1)

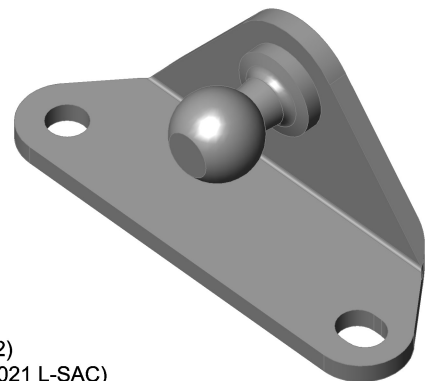

- 1 - Bolt (BS31302)
- 2 - Bracket (BR2021 L-SAC)

General Tolerances DIN ISO 2768-medium

(C) MK Material Oto. San. ve Tic. Ltd. Şti. All rights reserved.

Mea.	Tolerance	T. Max. Dim.	T. Min. Dim.	Material	Note
				-	-
	Name	Date	Signature	Plating	Quality control: <input type="checkbox"/> Product accepted. <input type="checkbox"/> Product rejected. <input type="checkbox"/> Product accepted conditionally. Date:
Drawn By				-	
Checked By					
Approved By					
Scale	Drawing No / Company Name			Rev. No	
1:1	BR202104I			01	